

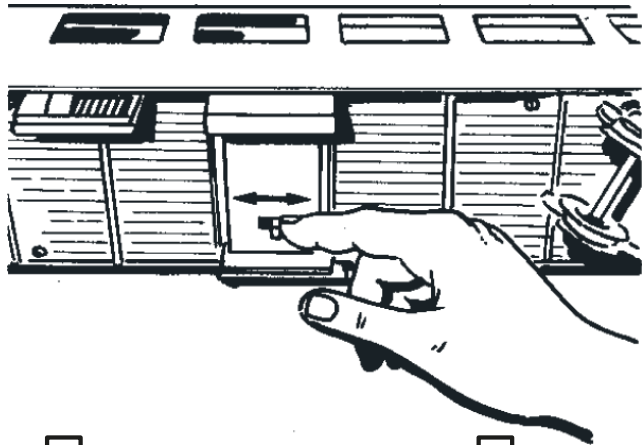

Personenwagen 1. Klasse A 1256

37676

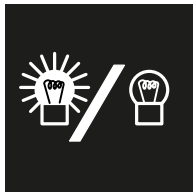

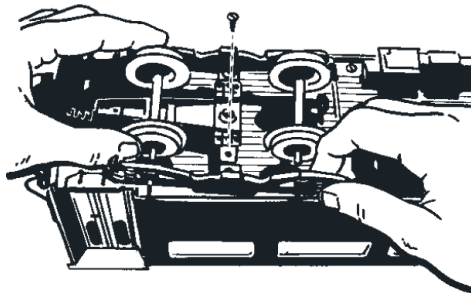
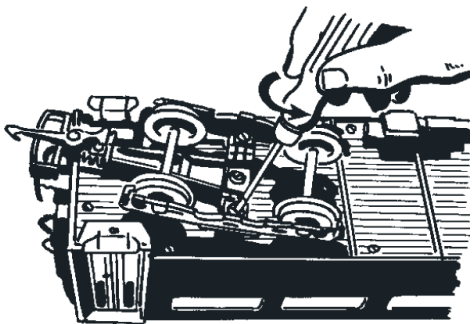
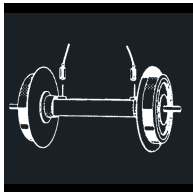

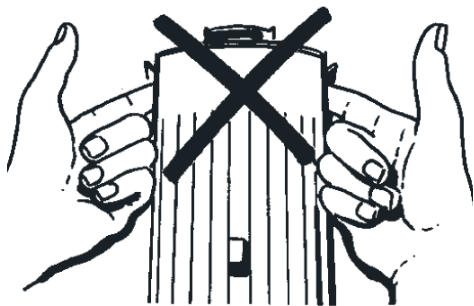

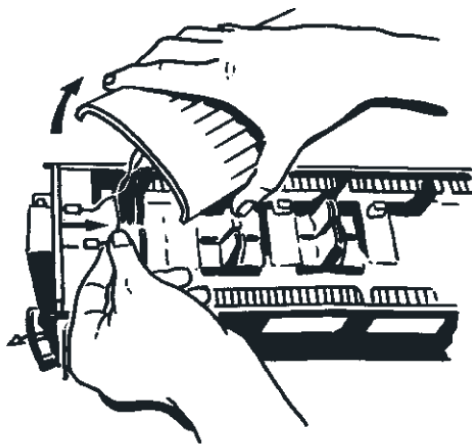

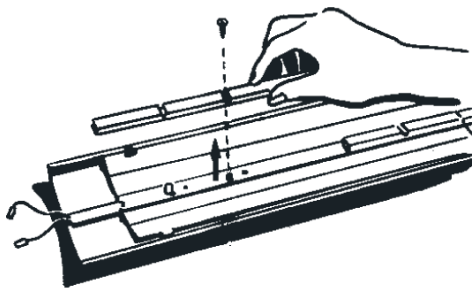
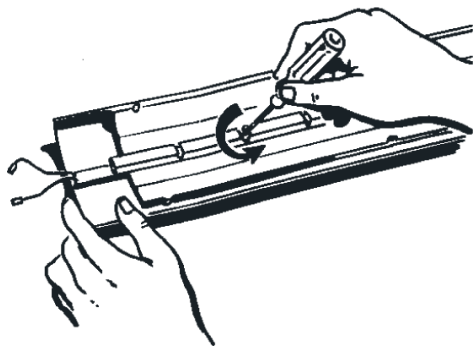

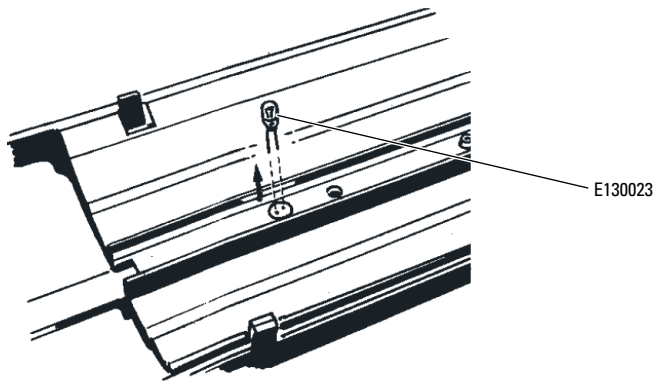

Gebr. Märklin & Cie. GmbH
Stuttgarter Str. 55 - 57
73033 Göppingen
Germany
www.lgb.de

241612/0414/Sm1Ef
Änderungen vorbehalten
© Gebr. Märklin & Cie. GmbH