

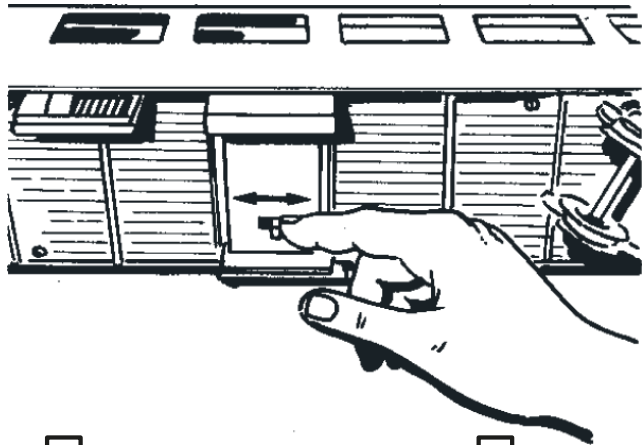

---

Personenwagen RhB 1./2. Klasse

**31678**

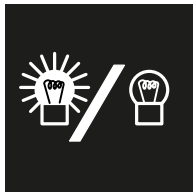

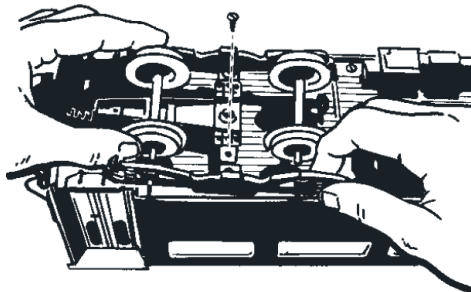
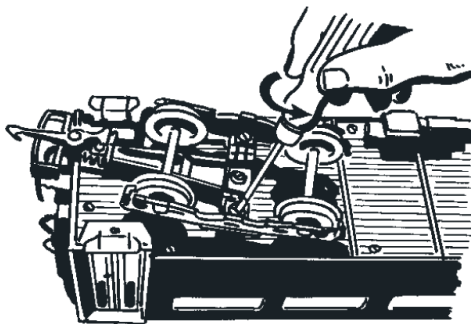
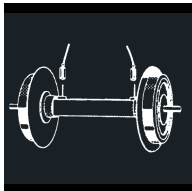



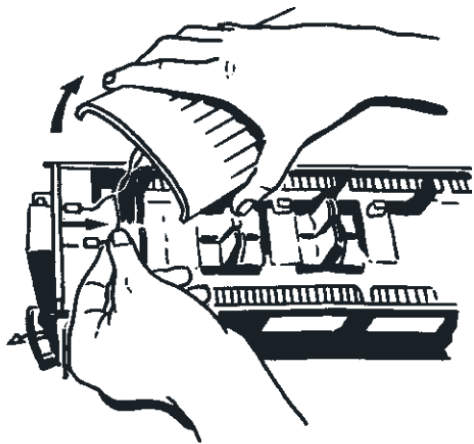

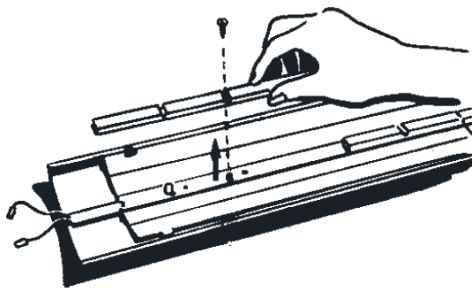
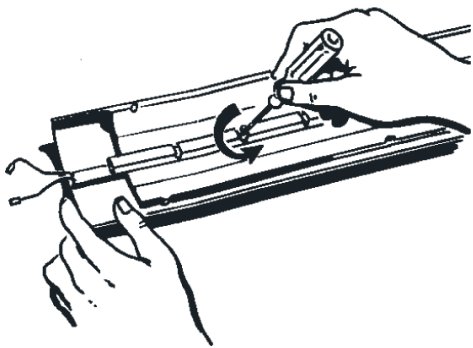

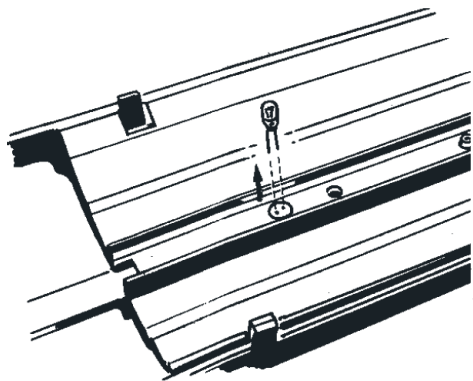

Gebr. Märklin & Cie. GmbH  
Stuttgarter Str. 55 - 57  
73033 Göppingen  
Deutschland  
[www.lgb.de](http://www.lgb.de)

168380/1011/Ma1Ef  
Änderungen vorbehalten  
© Gebr. Märklin & Cie. GmbH